

PORTABLE EQUIPMENT

N600



DUAL CHANNEL
VIBROMETER

SPECTRUM
ANALYSER

DATA
COLLECTOR

BALANCING
MACHINE



CEMB

BALANCING MACHINES

N600 PORTABLE EQUIPMENT

The solution for vibration analysis and balancing

10 Khz Dual channel instrument for balancing and vibration analysis

- 7" color graphic display
Very high luminosity and contrast for sunlight use
- Diagnosis and solutions in a simple, quick and intuitive way
- Always efficient machines and cost savings thanks to vibration monitoring and balancing
- Fast & accurate vibration measurements
- Powerful and versatile designed to perform extremely fast vibrometric controls, balancing in service and analysis on any rotating machine
- Indispensable to programming predictive and periodic maintenance
- PC interface by USB memory stick



STANDARD ACCESSORIES:

No. 2 accelerometer transducers 100mV/g

No. 2 transducers connection cables L 2,5m

No. 1 heavy duty coiled cable L 2m

No. 2 magnetic bases Ø 25 mm

No. 2 probes

No. 1 hi-speed photocell 250000 rpm complete with upright and magnetic base

No. 1 roll of reflecting tape

No. 1 USB stick for data transfer

No. 1 Angle rule

No. 1 battery charger

No. 1 Carrying case with carry strap

Manual

OPTIONAL ACCESSORIES:

Protective cover

Velocity transducer complete with magnetic base and cable

Transducer connection cable L 5m

Extension cable for transducer L 10m

Extension cable for photocell L 10m

N-PRO Software storage and data report

Route Manager Software

ADS Software storage, diagnostic and data report



N-PRO SOFTWARE

- PC Data storage
- Quick report creation by standard template
- Quick creation of customized reports
- Analysis and data processing.

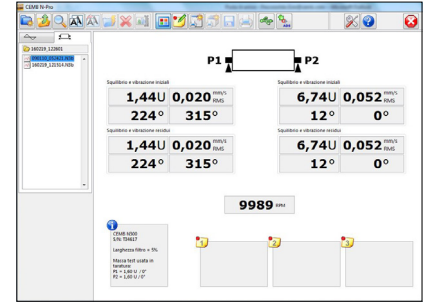
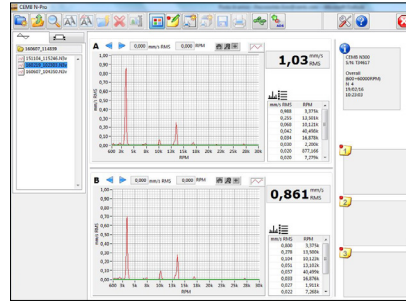

ROUTE MANAGER

Software for route creating that makes N600 a Data Collector for predictive maintenance.

- Intelligent storage of measurements acquired in the field
- Creating new routes
- Manage existing routes
- Saving routes and upload them on the N600 instrument
- Tree manager to add items to the database

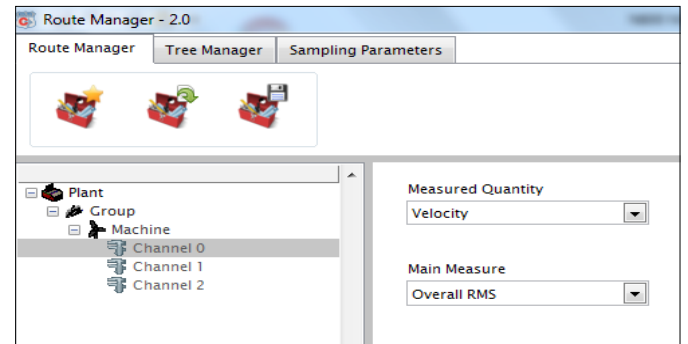

ADS - ADVANCE DIAGNOSTIC SOFTWARE

The software provides advanced diagnostic tools to meet every user needs: archive, detailed analysis, diagnostics, measurement comparisons, trends, spectra, and waveforms.

VERSATILE, COMPLETE AND INTUITIVE

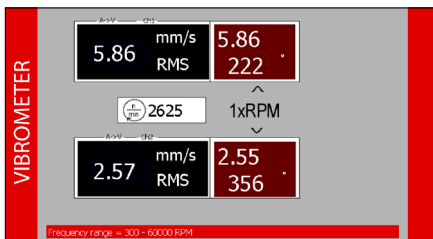

- Vibrometer function
- 2 Channel with Phase

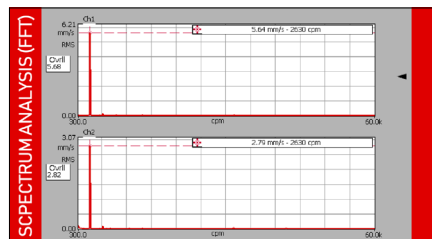

- FFT analyse with graphic zoom
- Peak cursors
- List of main peaks

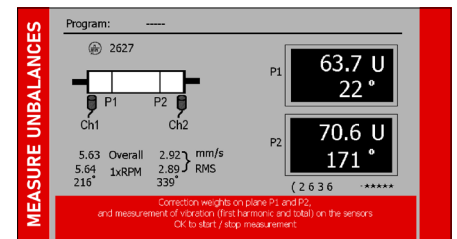

- Balancing function 1 or 2 planes
- Graphic indicator of measurement stability

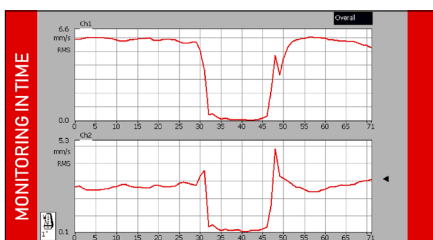

- Monitor Time
- Overall vibration trend over time

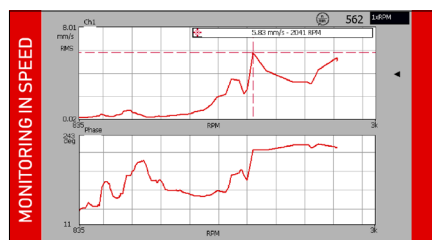

- Monitor Velocity
- Vibration value trend and phase at the speed variation

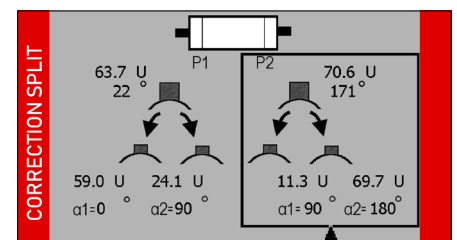

- Vectorial breakdown of the unbalance
- Correction by adding or removing material

CEMB

TECHNICAL DATA

GENERAL DATA

- Display: 7" colour LED-backlit TFT LCD
- Multifunction Keypad

MEASUREMENT TYPES

- Effective value (RMS)
- Peak value (Pk)
- Peak-to-peak value (Pk-Pk)

UNITS OF MEASUREMENT

- Acceleration: [g]
- Velocity: [mm/s] or [inch/s]
- Displacement: [μ m] or [mils]
- Frequency: [Hz] or [Cpm]

INPUT

- 2 independent and simultaneous measuring channels (accelerometer, velocimeter, non-contact, any signal max. 5V-PP)
- 1 photocell channel (velocity and angle reference)
- 2 USB ports for data transfer

VIBROMETER FUNCTION

- Measurement of the overall vibration (acceleration, velocity, displacement)
- Max. settable frequency (100; 500; 1000Hz; 2.5; 5; 10 kHz)
- Measurement of 1x fundamental vibration value and phase

FFT FUNCTION (ANALYSIS IN FREQUENCY)

- FFT analysis (manual/trigger)
- Maximum settable frequency (25; 100; 500; 1000Hz; 2.5; 5; 10; 15kHz)
- Resolution (100; 200; 400; 800; 1600; 3200 lines)
- Numbers of averages: from 1 to 16

MONITOR – DATA LOGGER FUNCTIONS

- Recording and display of overall vibration trend over time
- Storage and display of vibration trend and phase when rotation velocity changes
- Bode Plot

BALANCING FUNCTION

- Number of correction planes: from 1 to 2
- Vectorial breakdown of the unbalance
- Correction by adding or removing material

OPERATING CONDITIONS

- Temperature: from -10° to +50° C
- Air humidity: from 0 to 95% without condensate

POWER SUPPLY

- Rechargeable 6Ah Lithium battery
- Charging time: < 5 hours (when battery is fully discharged)
- Power supply-battery charger for 100-240 V, 50/60 Hz (24 V, 1.5 A)
- Battery life: > 8 hours based on typical use

DIMENSION WEIGHT AND PACKAGING

- Approx. mm 460(L) x 360(H) x 180(P) 6000g
- Packaging: carton box 58 x 25 x 52 mm

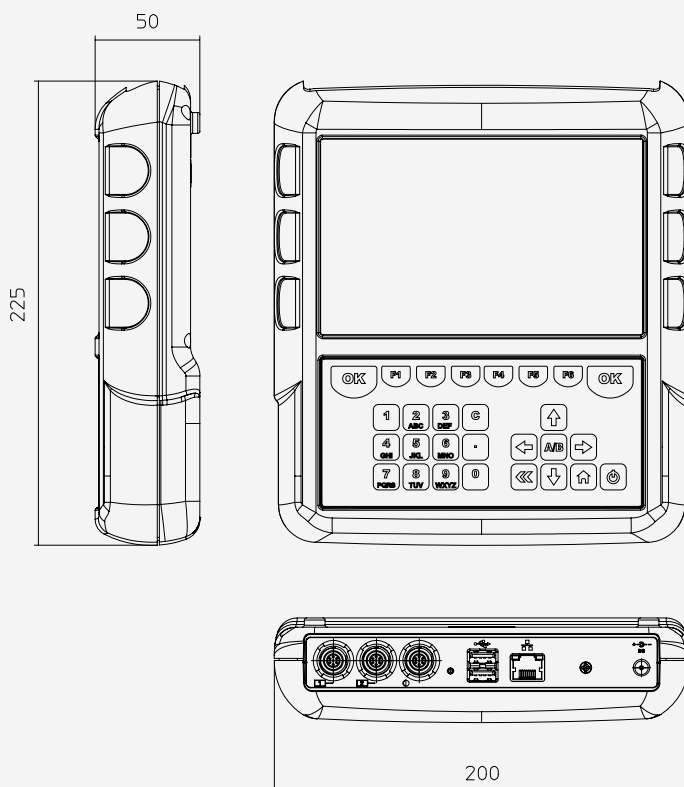

CEMB S.p.A. - Via Risorgimento, 9
23826 Mandello del Lario (LC) - Italy
www.cemb.com



Vibration analysis division:
Phone +39 0341 706111
e-mail: stm@cemb.com

All the data and features mentioned in this catalogue are purely for information and do not constitute any commitment on the part of our company, which reserves the right to make any and all alterations it may consider suitable without notice.