

# MH118-4A

Motor Fin Mount Probe Pad, 0.25 in. x 1.0 in. (6.35 mm x 25.4 mm)  
Probe Tip

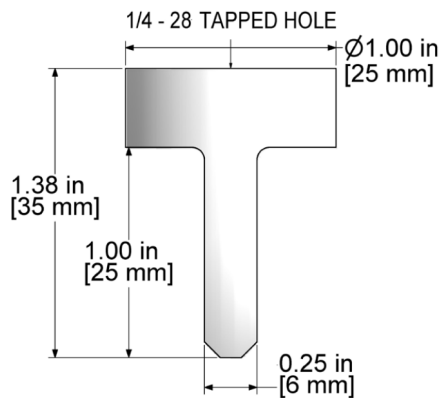

VIBRATION ANALYSIS HARDWARE



## Product Features

Mounts conveniently between motor cooling fans with use of adhesive

- ▶ Attracts magnetic bases for portable measurements
- ▶ Epoxy Catch side textures
- ▶ Permanently installed with adhesive



## Specifications

Case Material	17-4 Stainless Steel
Sensor Mounting	1/4-28 Tapped Hole
Field Mounting	Epoxy (Sold Separately)
Recommended Epoxy	CTC MH109-2A Sold Separately
Protective Cover	CTC CP101-2A Red Cap Cover

## Chemical Compatibilities for Reference

- ▶ Gasoline - A
- ▶ Methanol - A
- ▶ Lubricants - A

## Compatibility

- ▶ Compatible with all sensors with 1/4-28 mounting stud or bolt
- ▶ Conversion mounting studs sold separately

Stock Product

Backed by our Unconditional Lifetime Warranty

[www.ctconline.com](http://www.ctconline.com) | [sales@ctconline.com](mailto:sales@ctconline.com) | 585-924-5900