

DD100780 Series

Eddy Current Driver Compatible with 11 mm Proximity Probe Systems, Voltage Output



Product Features

PRO Line Proximity Drivers pair with PRO Line Proximity Probes to offer configurable machinery protection with high quality components and industry best lead time

API Standard 670 specified format

- ▶ Isolated voltage output standard at BNC and terminal block Vout and Com
- ▶ Upgraded to include SecureLock connector

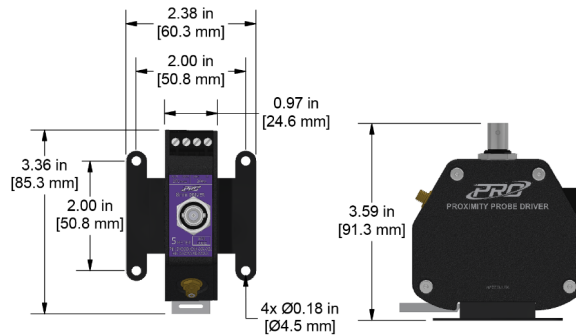

Specifications

Temperature Range	-49 to 185 °F (-45 to 85 °C)
Enclosure	Aluminum
Probe Connector	SecureLock
Power & Output Connector	4 Position Terminal Block & BNC
Input Voltage	-17.5 to -30 VDC
Linear Range	20-180 mils (0.5 - 4.5 mm)
Nominal Voltage Output	-100 mV/mil (-3.94 V/mm)

Built to Order

Lifetime Warranty on Materials & Workmanship
www.ctconline.com | sales@ctconline.com | 585-924-5900